

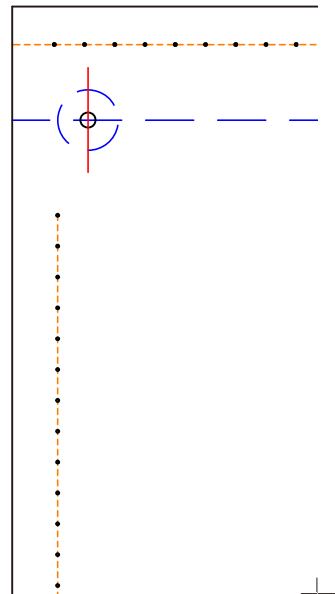

皮小匠图纸 <http://www.pixiaojiang.com>

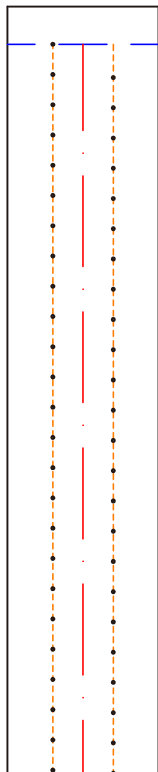

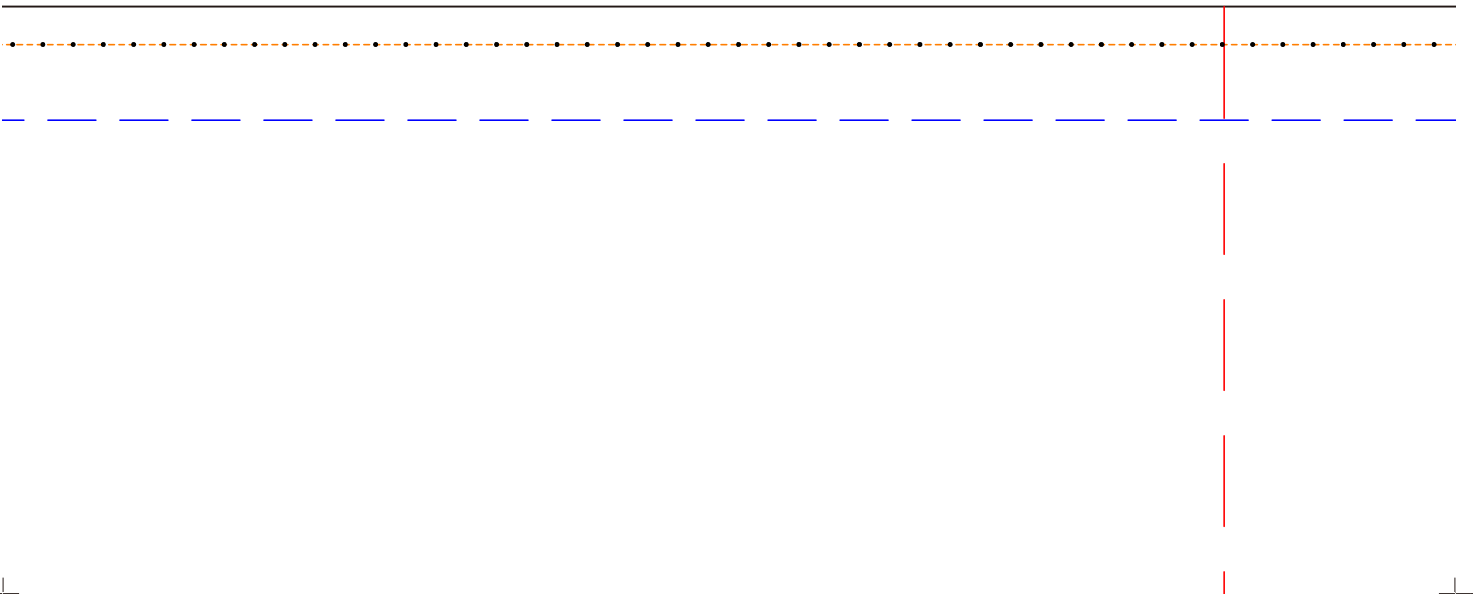



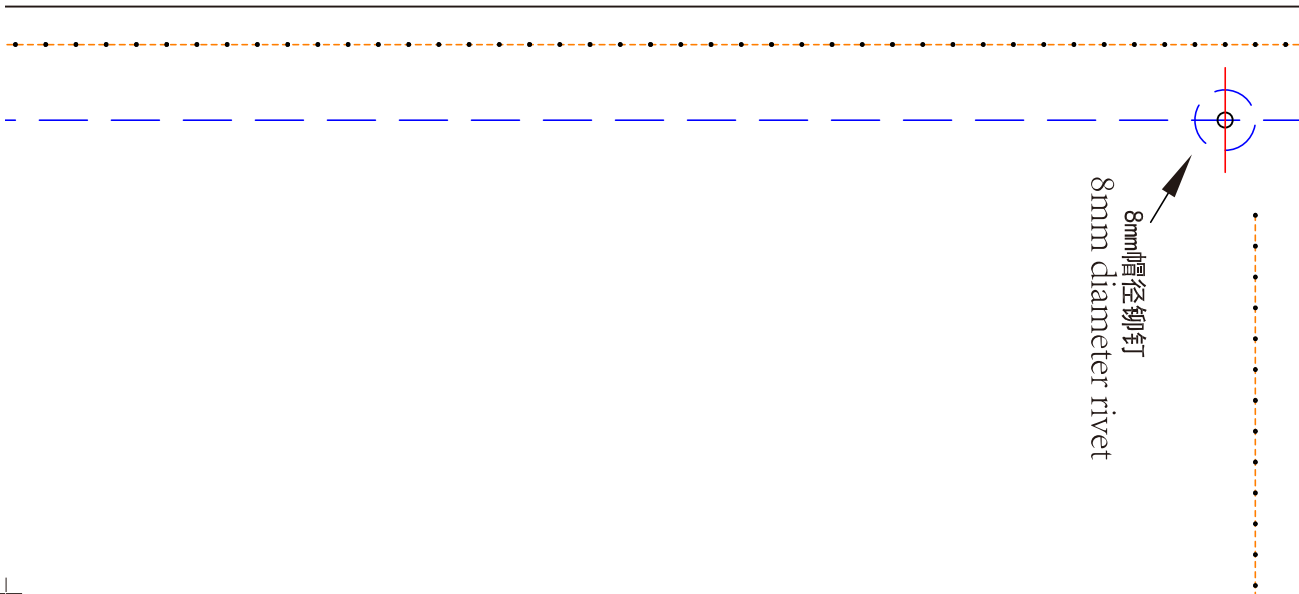

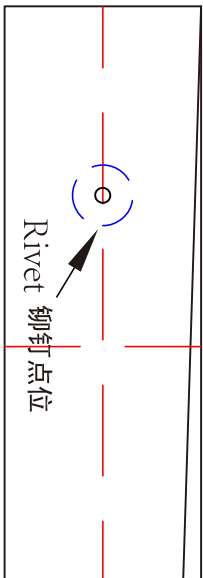

Rivet 铆钉点位



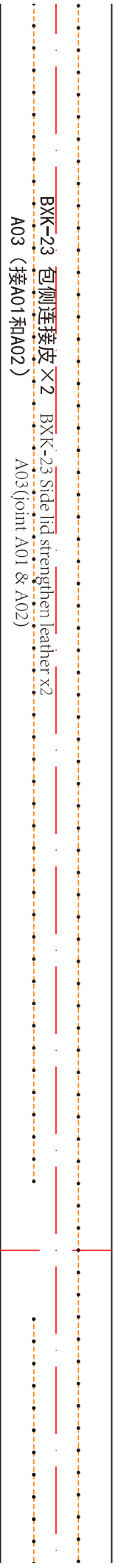
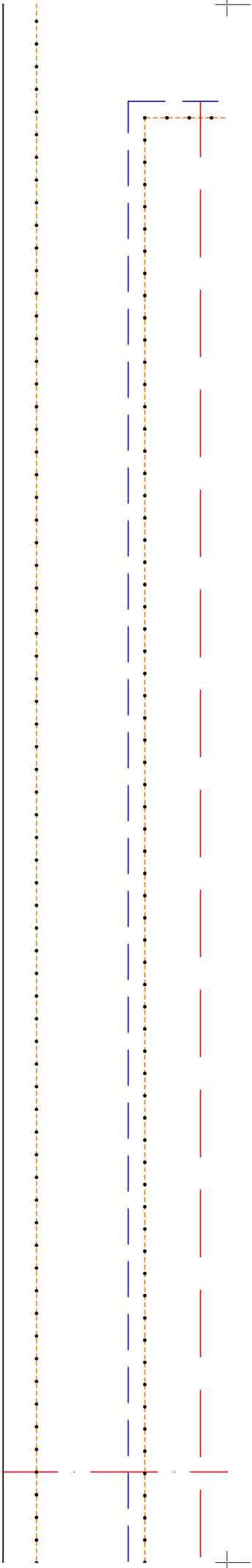

BKK-23 包侧连接皮 ×2 BKK-23 Side lid strengthen leather x2
 A03 (接A01和A02) A03 (joint A01 & A02)

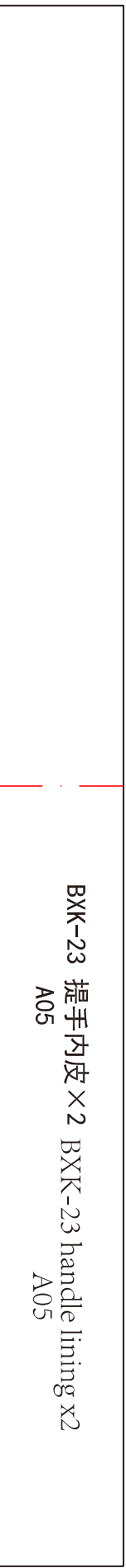

BKK-23 提手内皮 ×2 BKK-23 handle lining x2
 A05 A05

BKK-23 包身 × 1
A01
BKK-23 Body x1
A01

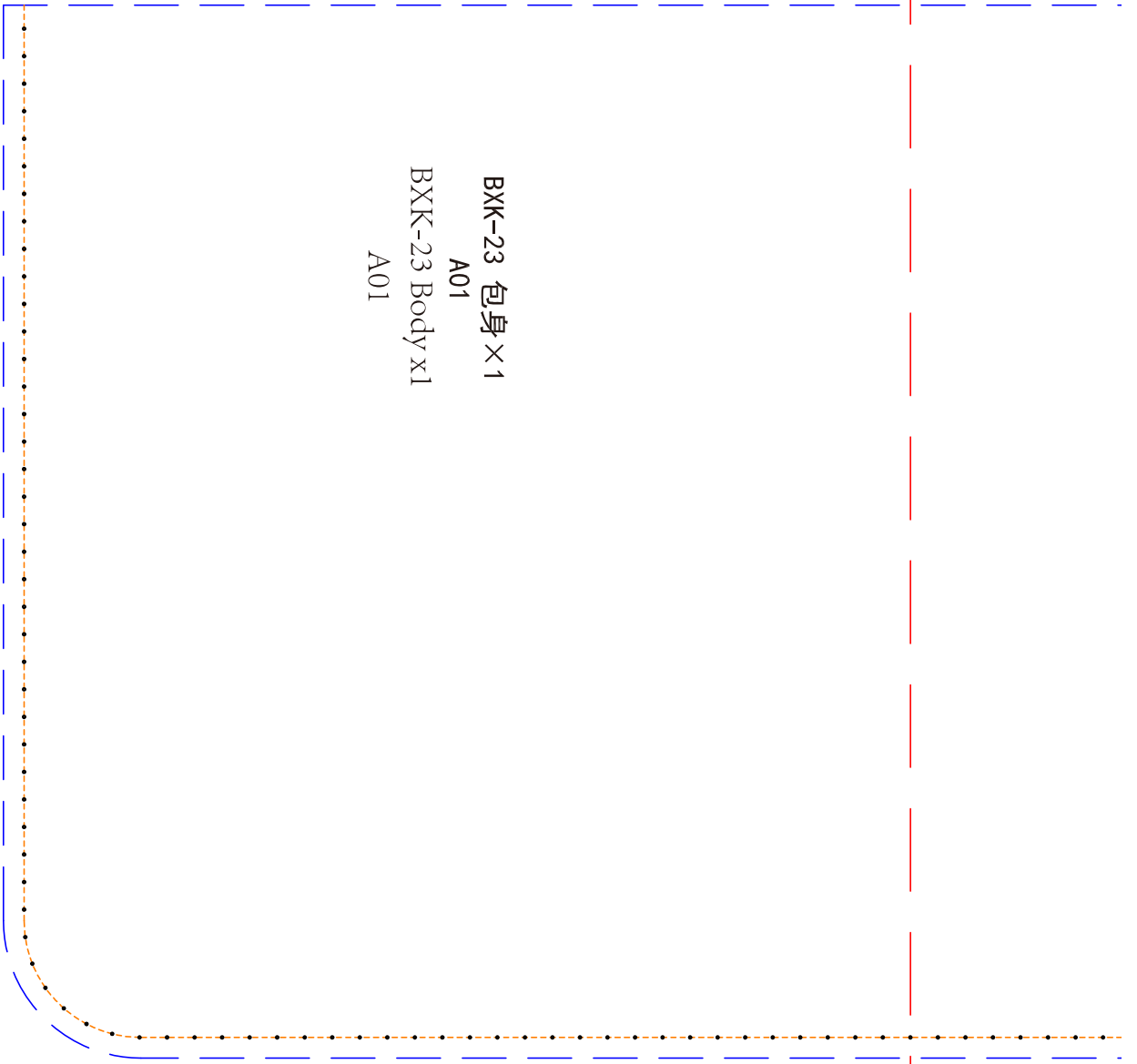

A04 安装定位线
A04 install orienting line

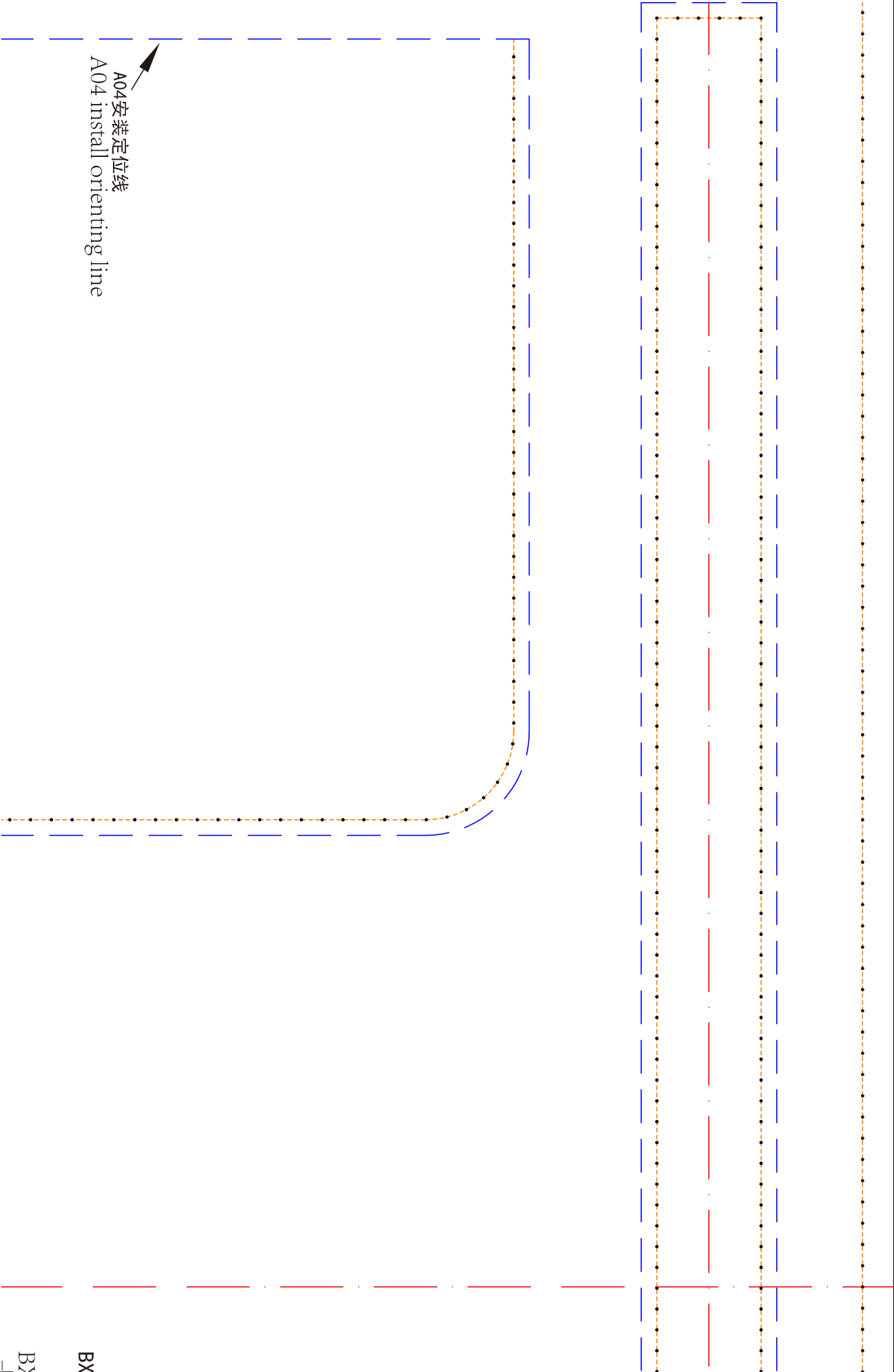

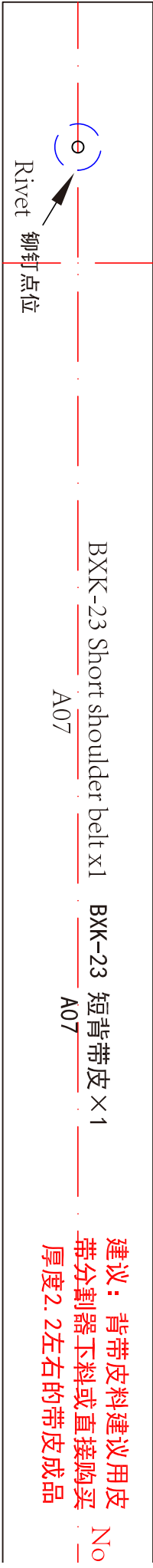

建议：背带皮料建议用皮
带分割器下料或直接购买
厚度2.2左右的带皮成品

建议：背带皮料建议
带分割器下料或直接
厚度2.2左右的带皮



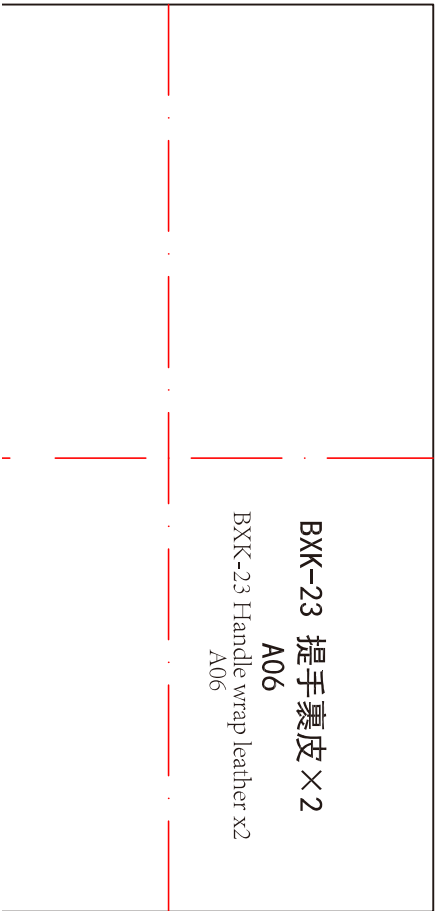
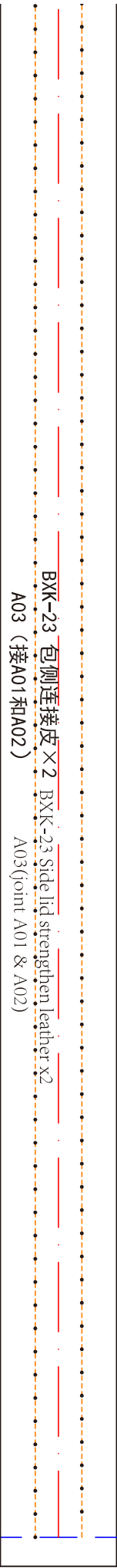
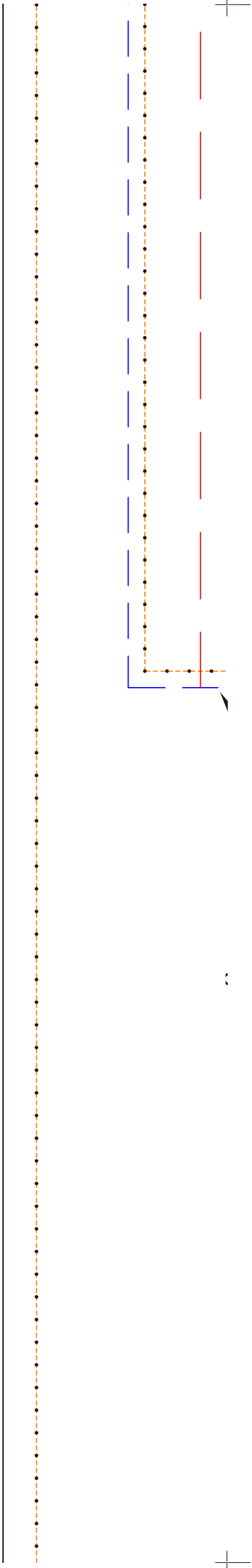

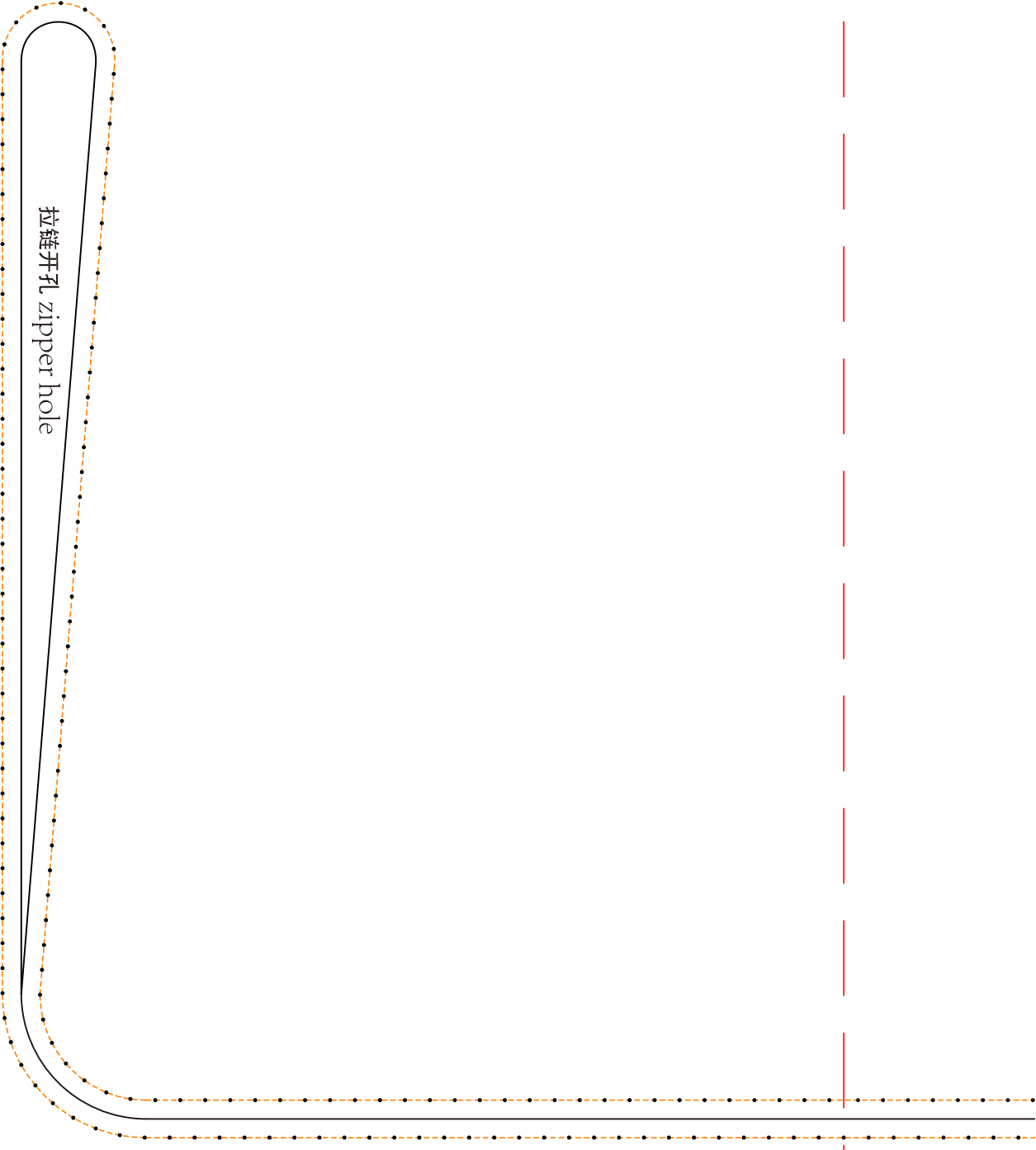

拉链开孔 zipper hole

A08 安装定位线
A08 install orienting line

K-23 包身 × 1
A01
KK-23 Body x1

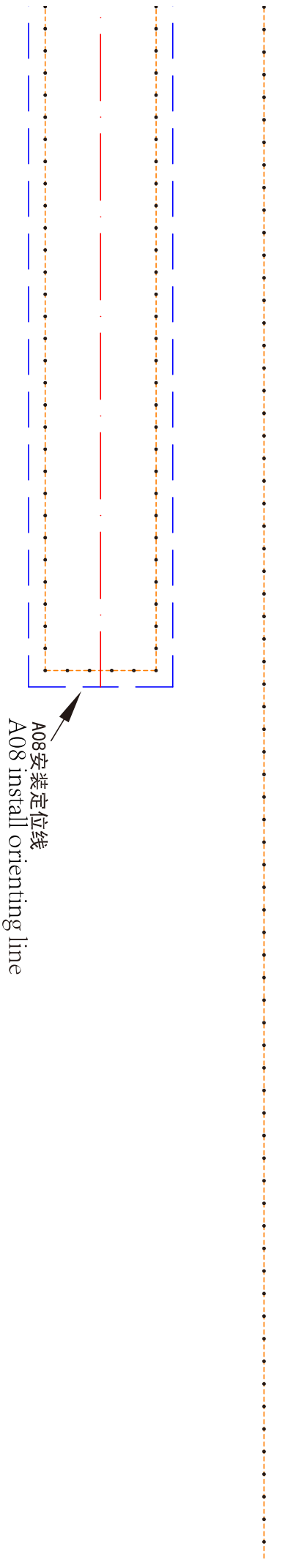

拉链开孔 zipper hole

A08 安装定位线
A08 install orienting line

注意： 此部分拉链孔位在皮料上做挖空处理，并在皮料上沿黑色实线裁开

拉链建议M6或5号 码装70cm

Note: Cut the black line, and hollow the zipper hole, M5 or No5 zipper, 70cm

用品
购买 Note: Use leather strip cutter
成品

BKK-23 长背带皮 (包身两侧扣带) ×3 BKK-23 Long shoulder belt x3
A08 A08

te: Use leather strip cutter

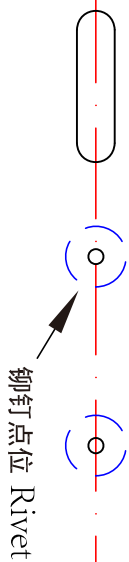

LZpattern
BXX-23 Bucket
A0 print 1:1

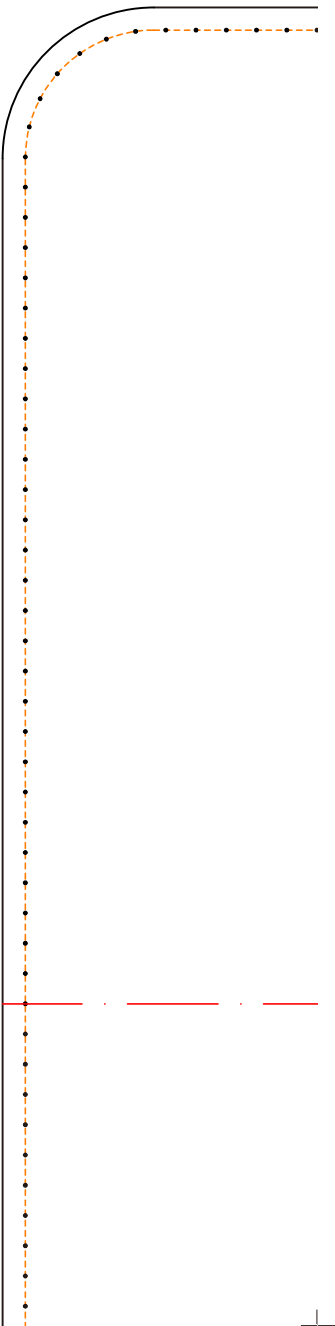
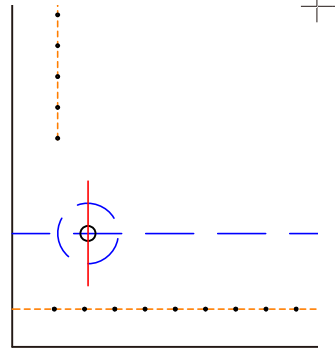
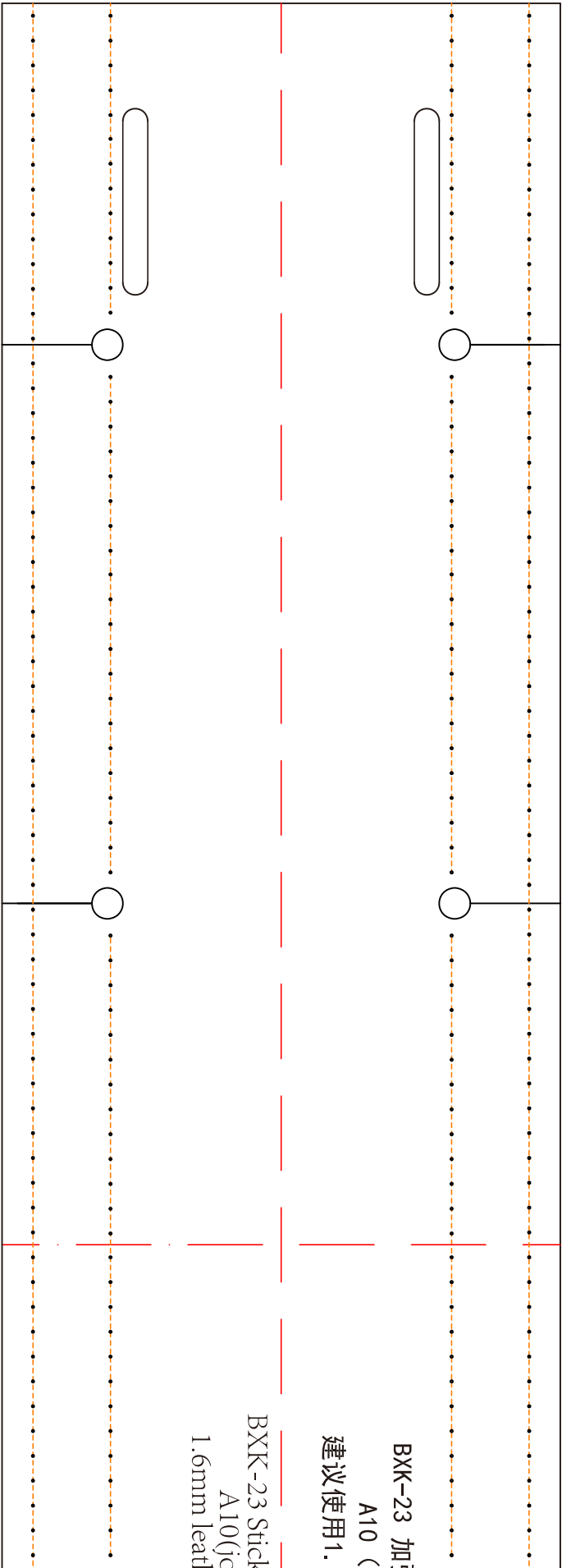

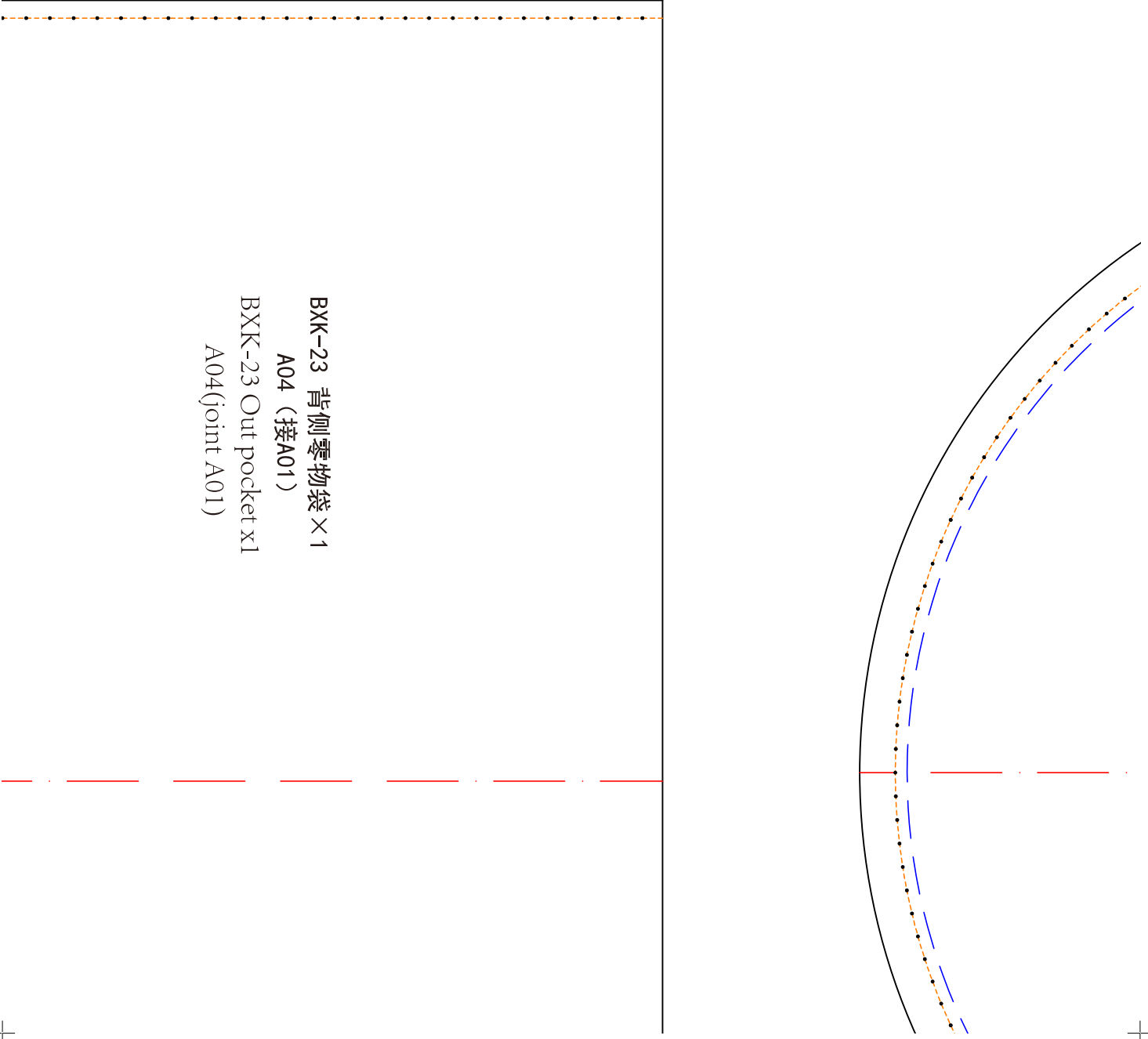
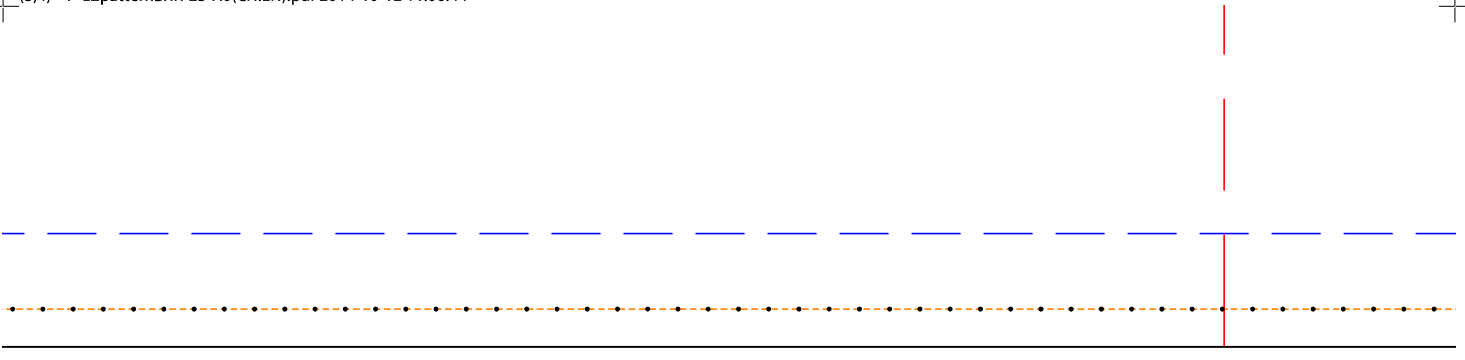

BKK-23 背侧零物袋×1
A04 (接A01)
BKK-23 Out pocket x1
A04(joint A01)

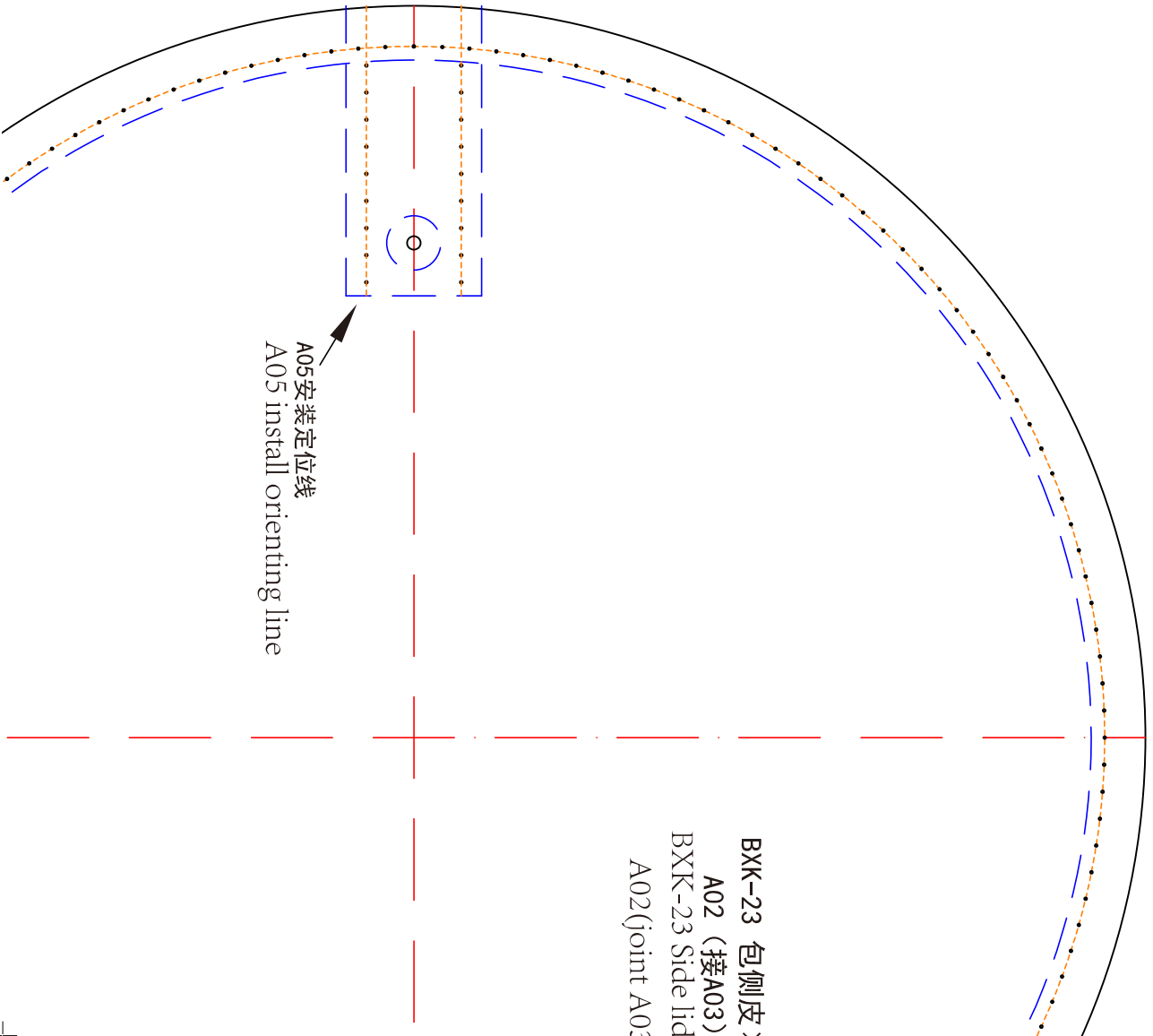
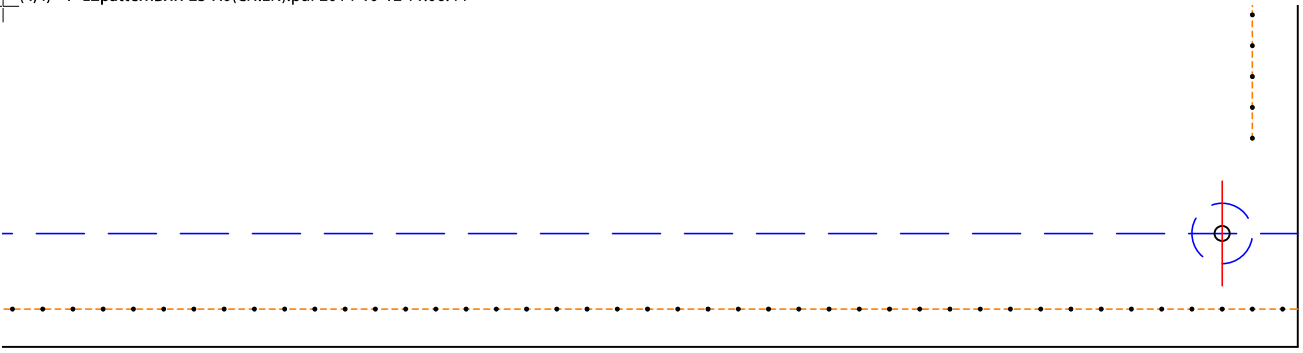

A05 安装定位线
A05 install orienting line

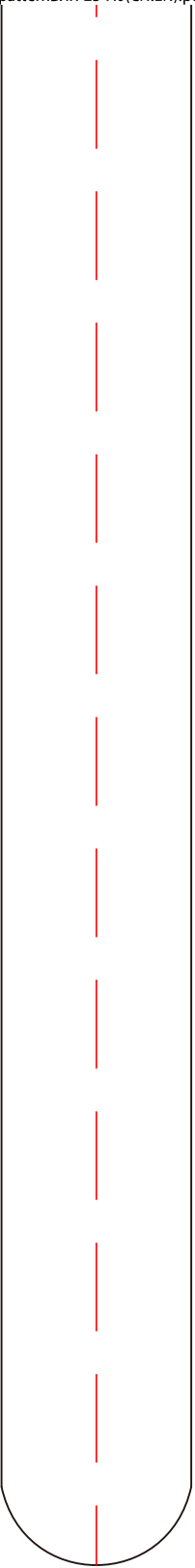

BXX-23 长背带

BXX-23 L01

ibag



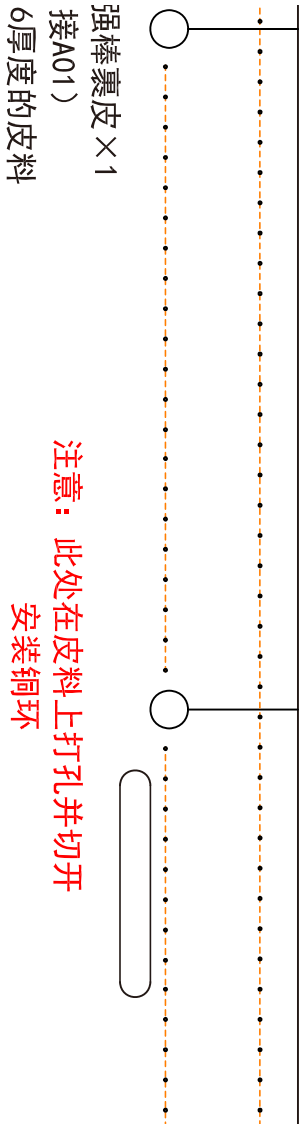
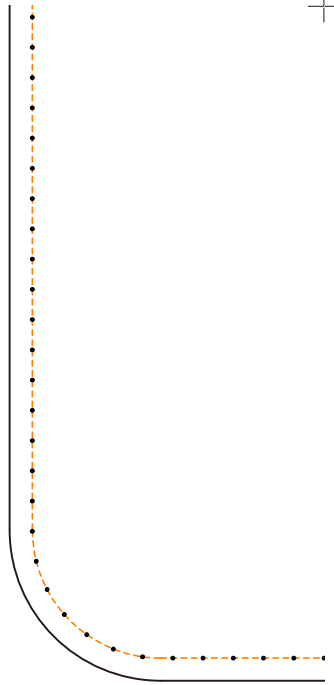

强棒裹皮×1
接A01)
6厚度的皮料

注意：此处
在皮料上打孔并
切开
安装铜环

wrap leather x1
oint A01)
her is adviced

Note: hollow the hole and install copper ring

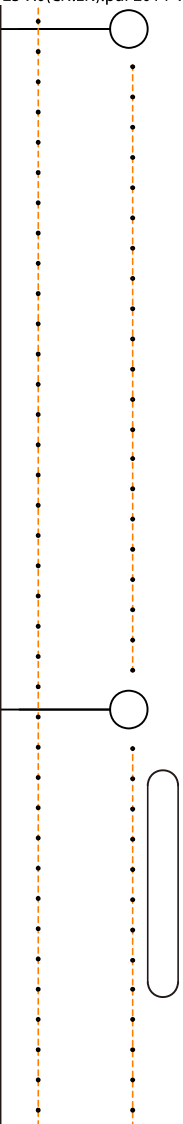

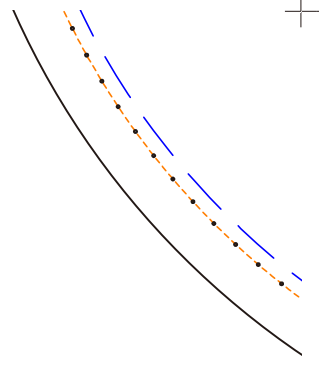

×2
3)

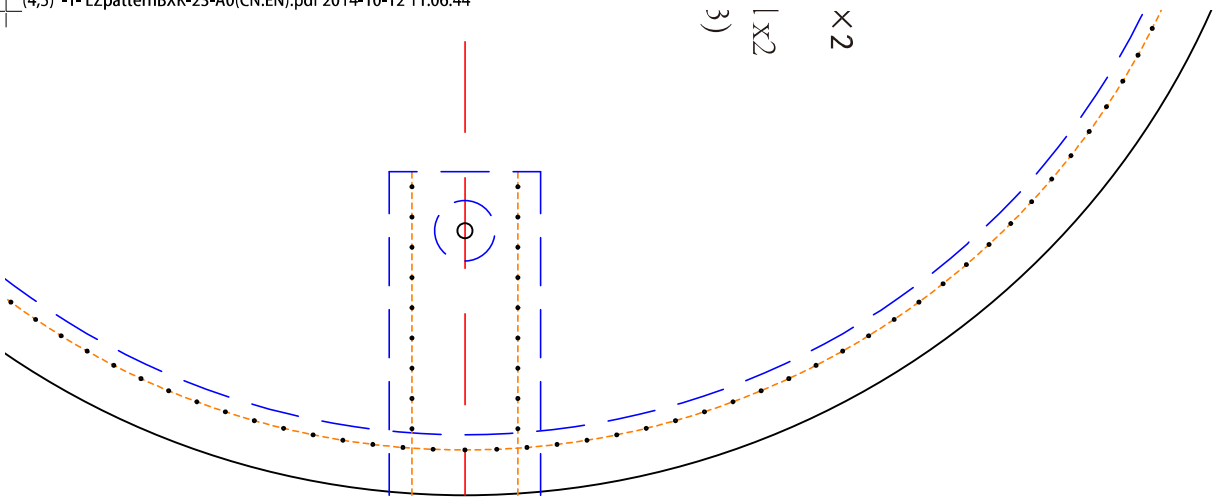

(包身两侧扣带) 扣袷×3
A09

ing shoulder belt ring x3
A09